















































domo

SOLA-
PES

Referencia	Sección	Designación	Peso g / ml	Perímetro dm2 / ml	Inercia lx cm4	Inercia ly cm4
2817		Solape 31 mm	213	12.6		
2834		Forro liso de 45 mm	427	23.7		
2835		Forro liso de 60 mm	478	26.7		
2836		Forro liso de 85 mm	567	31.7		
2837		Forro liso de 45 mm	475	26.4		
2838		Forro liso de 60 mm	527	29.4		
2839		Forro liso de 85 mm	616	34.4		
2840		Forro liso para registro de 45 mm	521	29.3		
2841		Forro liso para registro de 60 mm	572	32.3		
2842		Forro liso para registro de 85 mm	662	37.3		
2843		Complemento para registro	176	12.0		
2848		Forro recto de 40 mm	411	22.1		
2849		Forro de 45 mm	438	22.9		
2850		Forro de 45 mm	548	28.8		
2851		Forro de 85 mm	648	33.7		
2852		Complemento de forro	324	18.6		
2853		Grapa solape	308	13.4		
2854		Solape clipar 70 mm	351	21.0		
2855		Solape 35 mm	240	13.2		
2858		Solape clipar 40 mm	302	17.5		
2859		Grapa de solape	114	12.0		
2860		Forro de clipar 45 mm	381	23.6		
2861		Sujeta tablero	140	12.0		
2862		Forro de clipar 85 mm	524	31.6		

Referencia	Sección	Designación	Peso g / ml	Perímetro dm2 / ml	Inercia lx cm4	Inercia ly cm4
2864		Solape 49 mm	389	22.8		
2865		Forro 45 mm	459	25.7		
2866		Forro 85 mm	600	33.7		
2867		Forro de clipar recto 40 mm	354	23.2		
2868		Solape 40 mm	274	15.4		
2869		Inversor galerías	459	24.8		
2870		Junquillo inversor galerías	143	12.0		
2871		Forro de clipar recto 85 mm	512	32.2		
2872		Solape recto 70 mm	564	25.7		
2873		Forro recto 44 mm	418	23.9		
2874		Forro recto 60 mm	500	27.0		
2875		Forro recto 85 mm	594	31.9		
2876		Forro recto 85 mm	298	17.3		
2877		Solape recto atornillado 45 mm	281	18.3		
2878		Forro 60 mm	538	27.9		
2879		Grapa para solapes	196	10.9		
2880		Solape 70 mm monoblock para atornillar	375	23.2		
2881		Solape 70 mm clip para monoblock	334	21.0		
2887		Solape monoblock 35 mm	292	18.4		
2891		Forro curvo 95 mm	666	35.3		

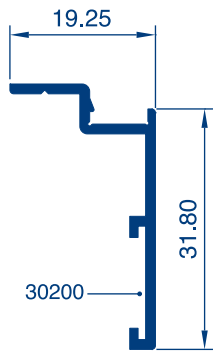
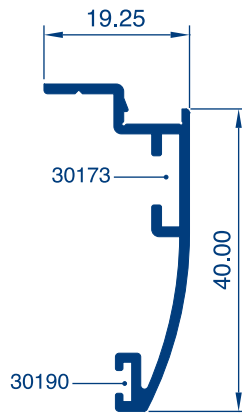
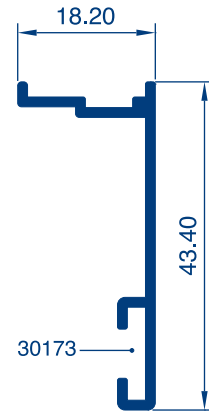
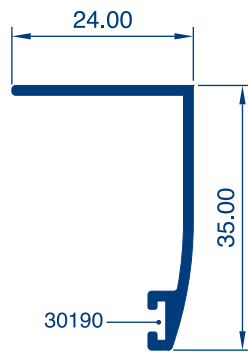
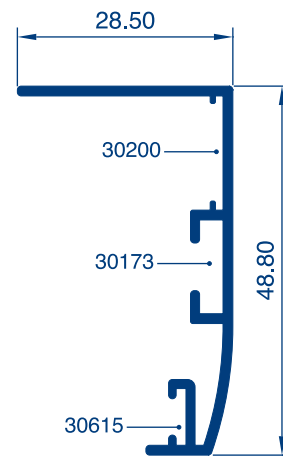
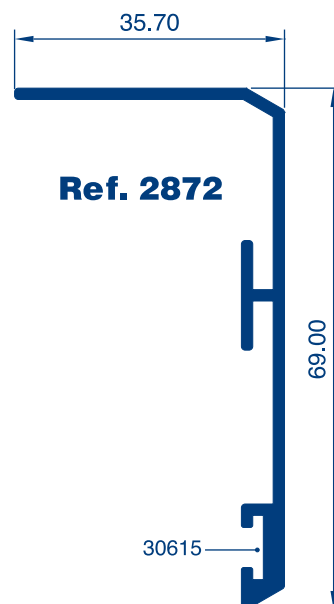
**Ref. 2817****Ref. 2876****Ref. 2868****Ref. 2855****Ref. 2864****Ref. 2872**

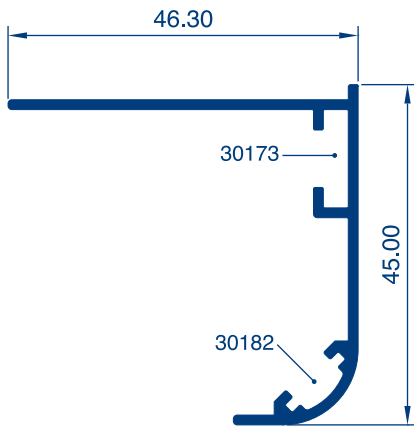

Ref. 2834

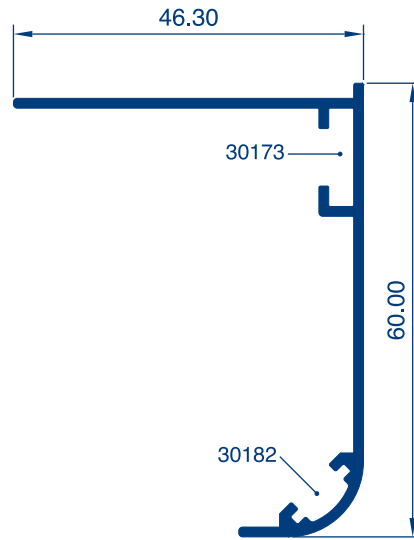

Ref. 2835

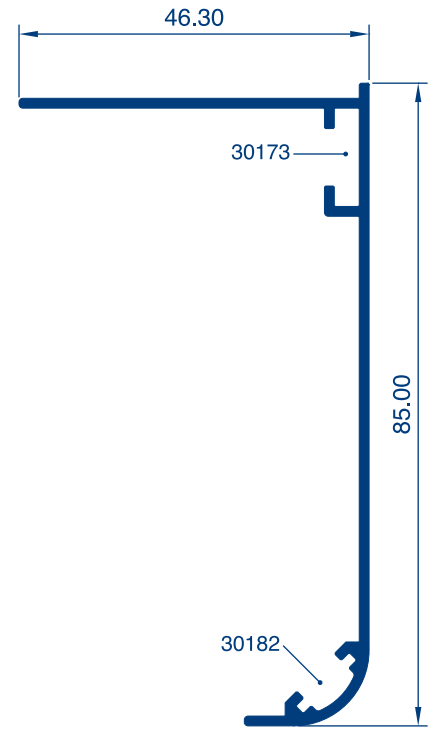

Ref. 2836

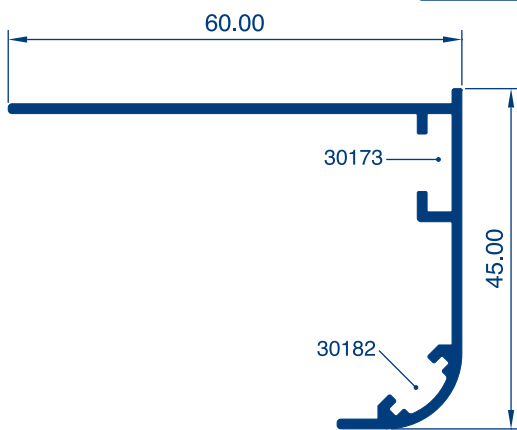

Ref. 2837

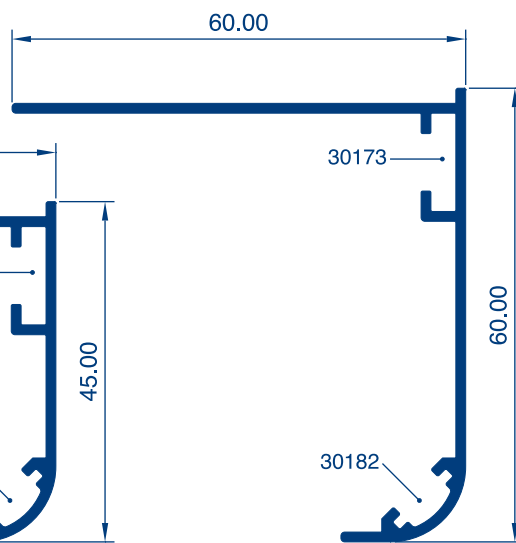

Ref. 2838

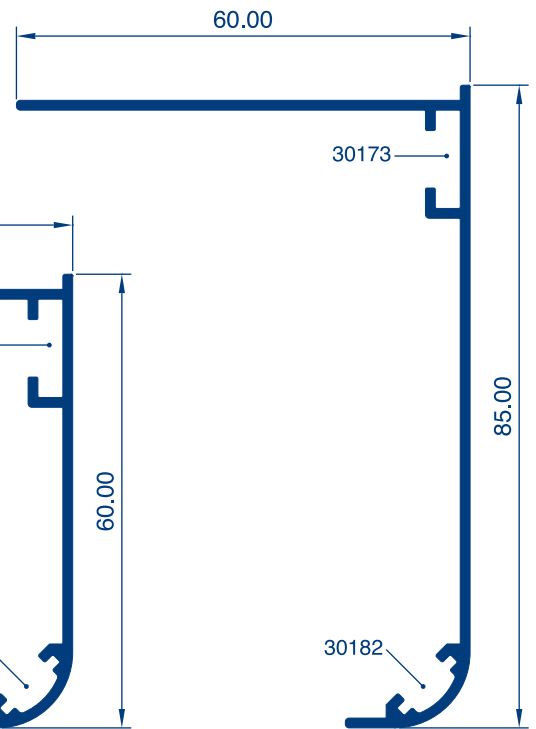

Ref. 2839

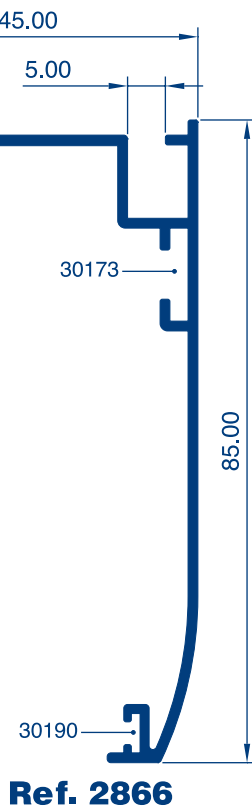
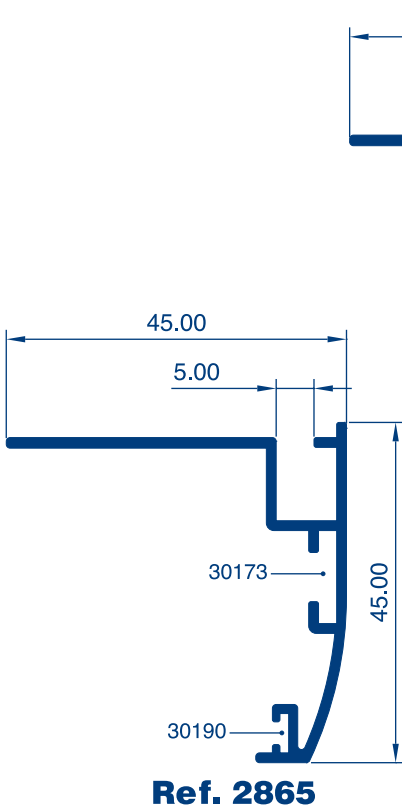
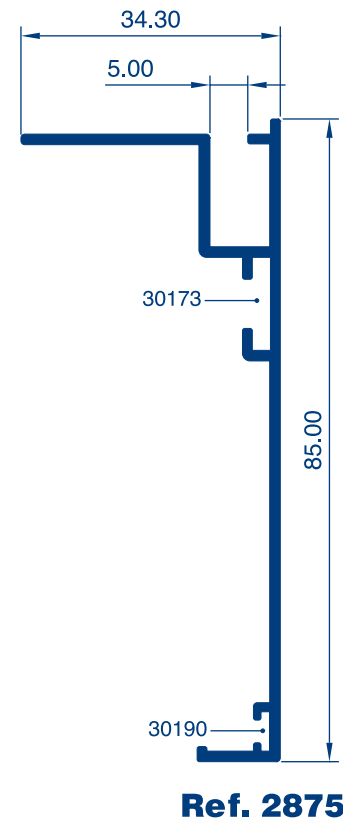
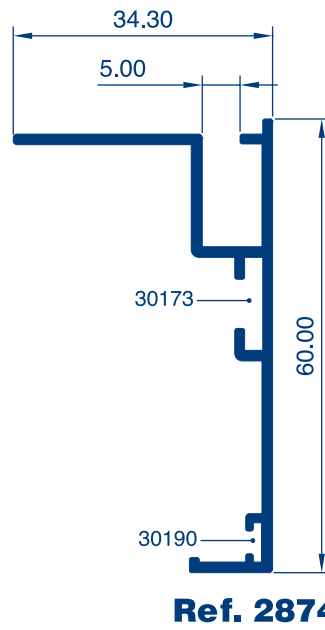
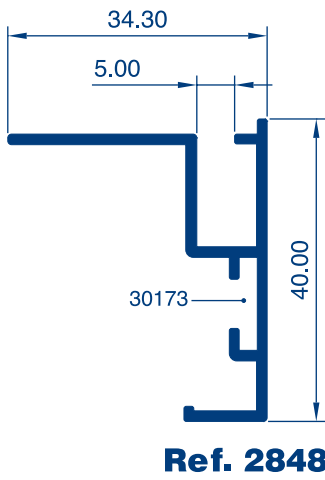
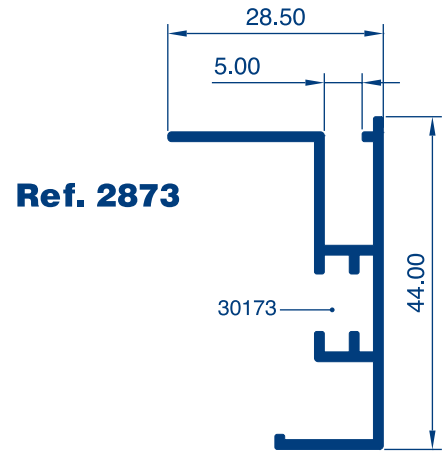
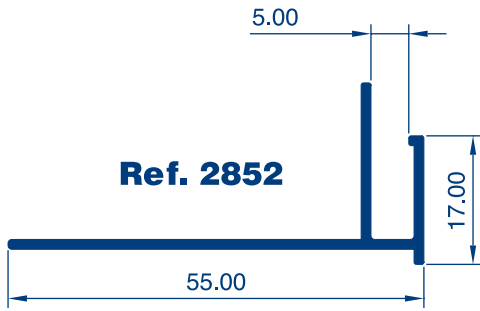

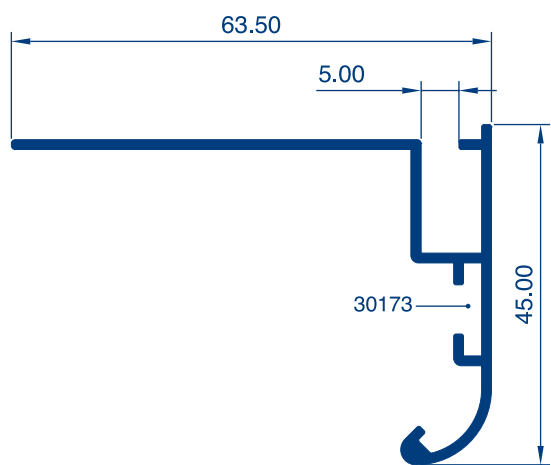

Ref. 2850

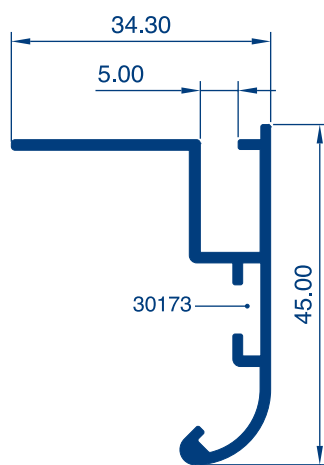

Ref. 2849

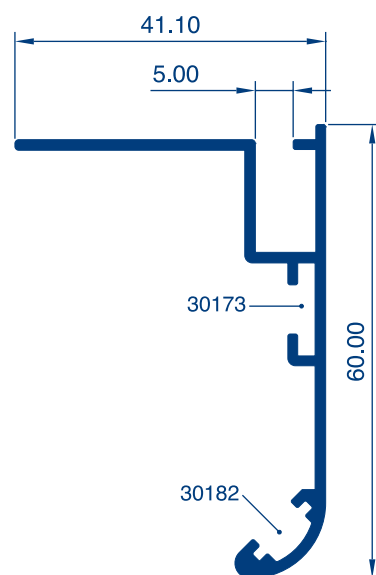

Ref. 2878

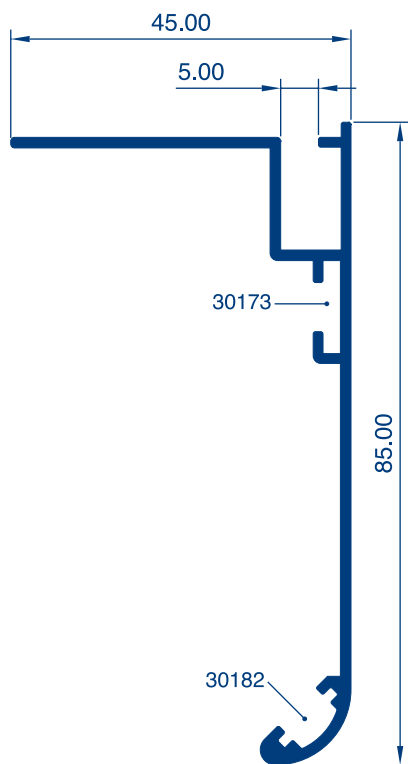

Ref. 2851

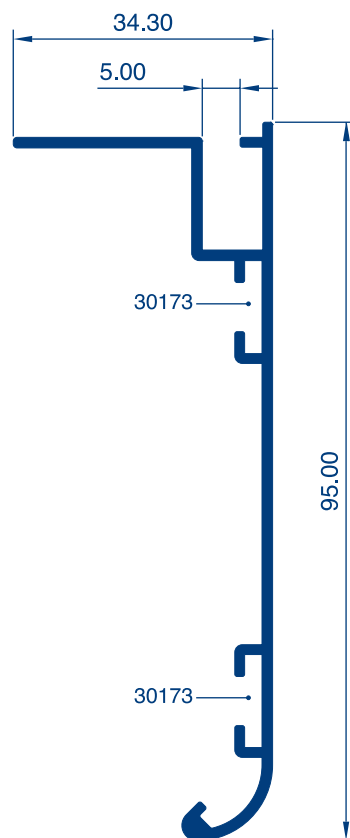

Ref. 2891

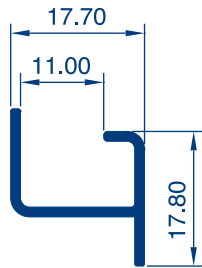
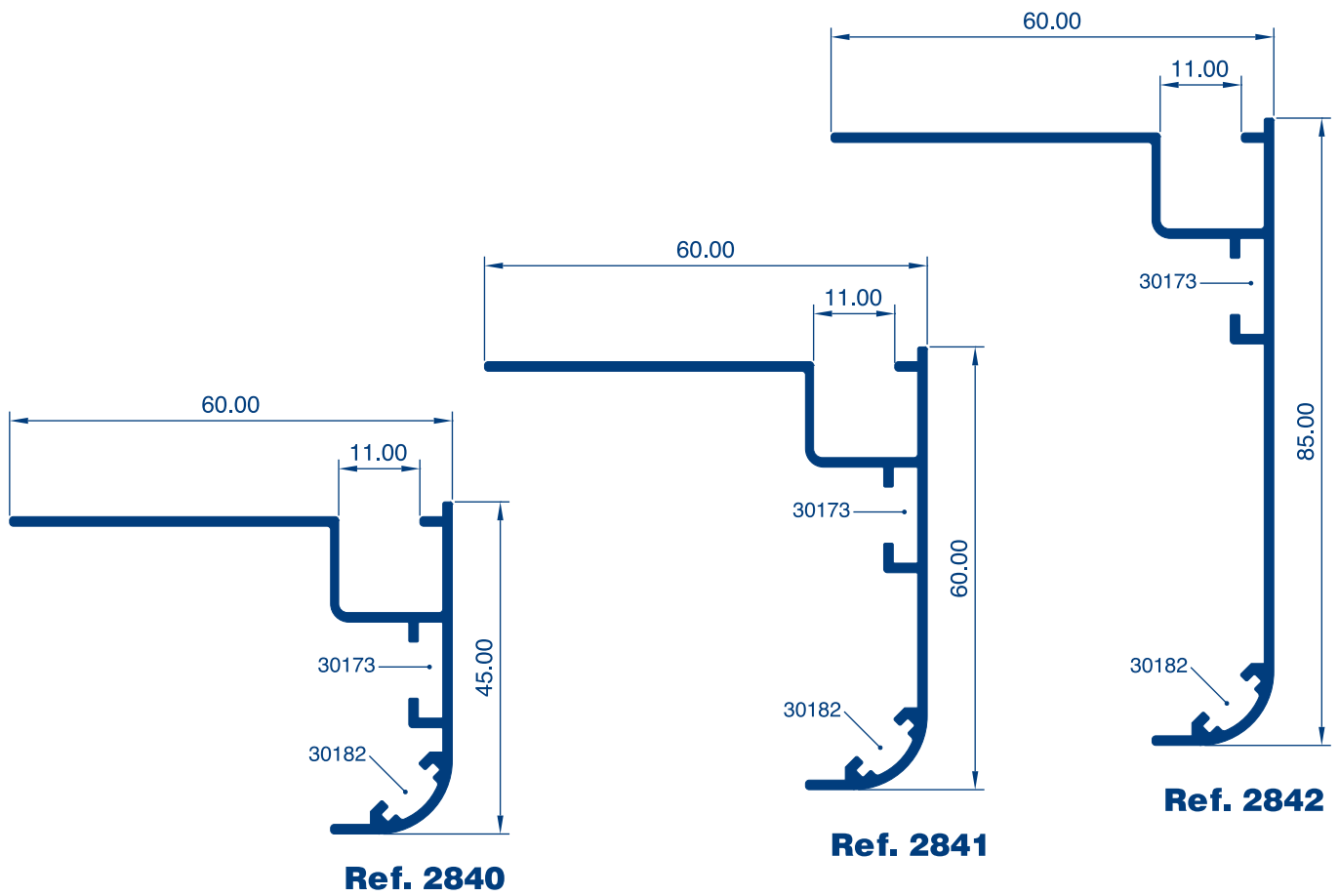
**Ref. 2843**



Ref. 2861

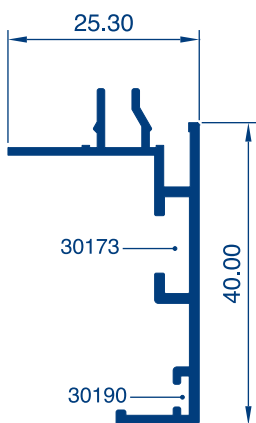

Ref. 2867

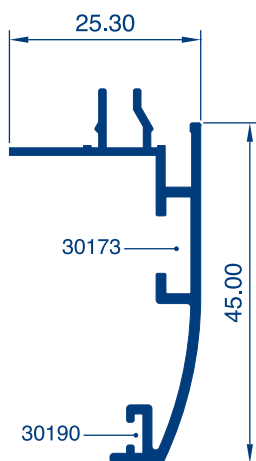

Ref. 2860

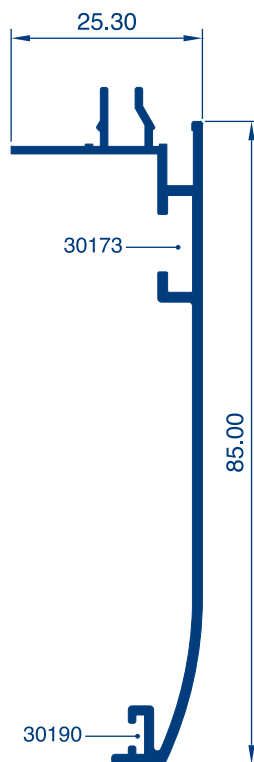

Ref. 2862

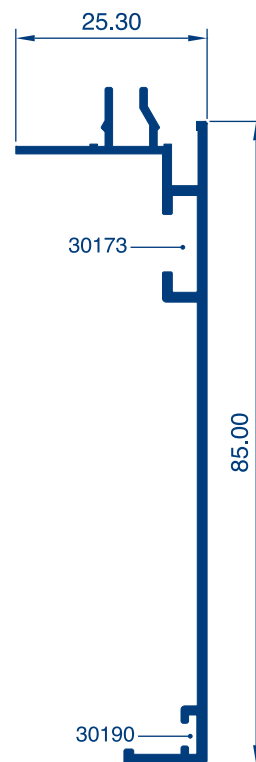

Ref. 2871

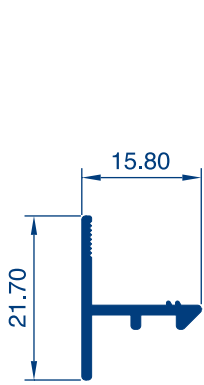

Ref. 2870

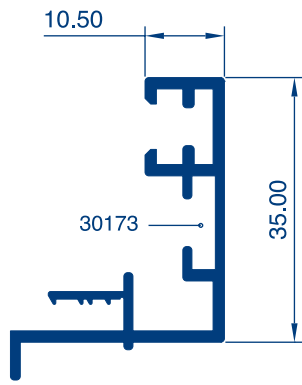

Ref. 2869

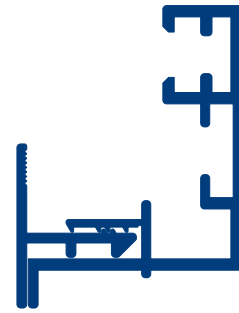

Ref. 2859

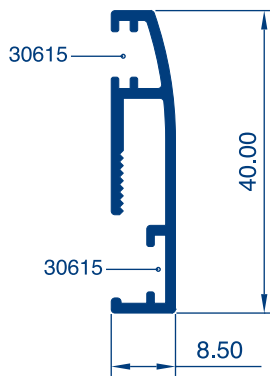

Ref. 2858

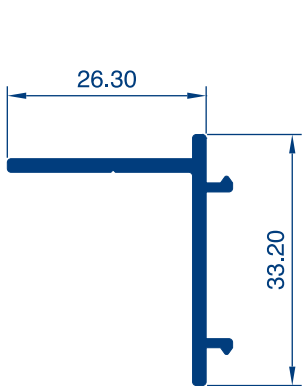
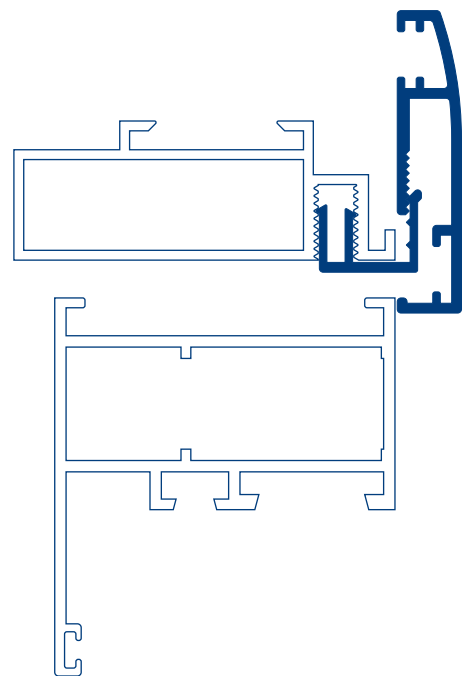

Ref. 2853

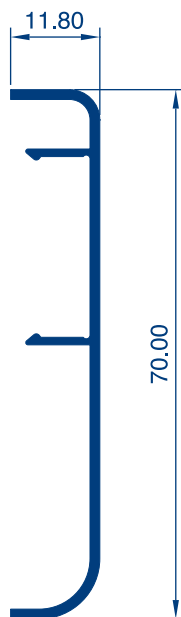

Ref. 2854



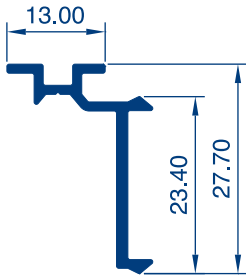

Ref. 2879

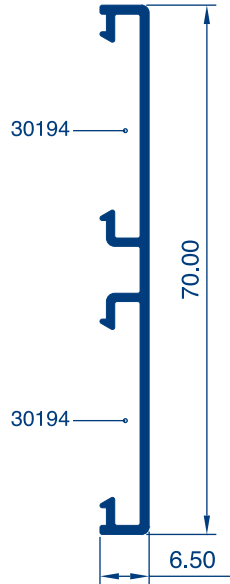

Ref. 2881

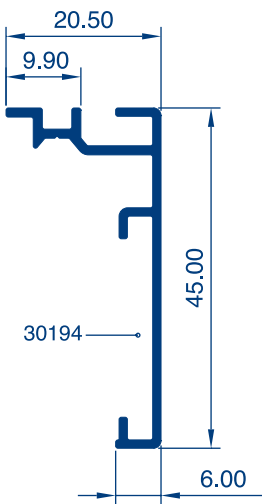

Ref. 2877

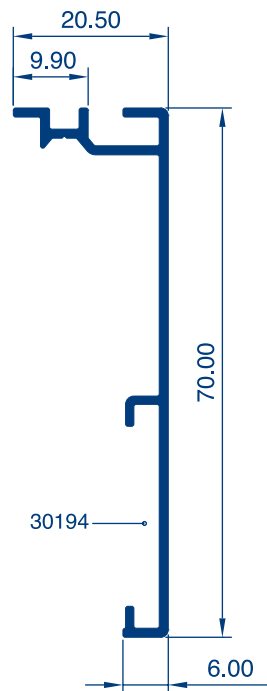

Ref. 2880

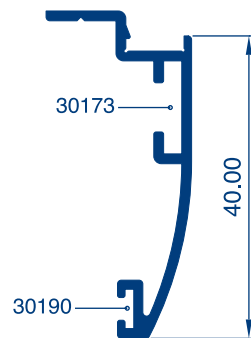

Ref. 2876

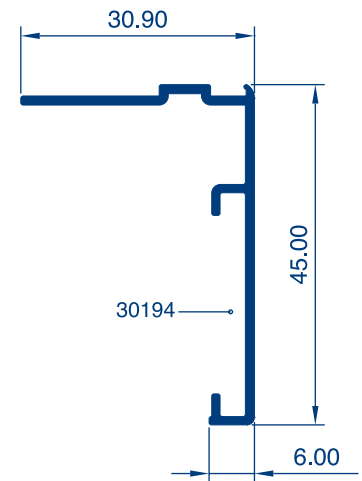

Ref. 2887

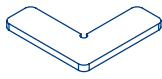

**Ref.
30190**

Escuadra alineación
15x5x0.8

100uds / bolsa
500uds / bolsa

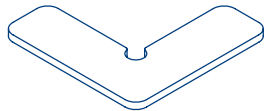

**Ref.
30615**

Escuadra alineación
25x8.5x1.2

50uds / bolsa

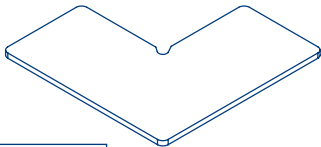

**Ref.
30200**

Escuadra alineación
30x15x0.8

100uds / bolsa
500uds / bolsa

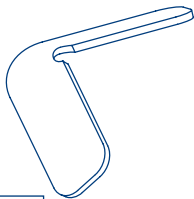

**Ref.
30182**

Escuadra forro
curvada
59x29x3.5

xxxuds / bolsa

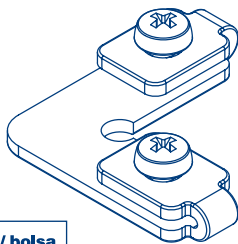

**Ref.
30173**

Escuadra forro
con tornillo
59x29x3.5

xxxuds / bolsa

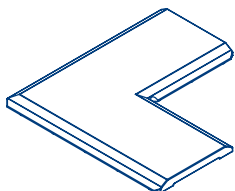

**Ref.
30194**

Escuadra alineación
59x29x3.5

500uds / bolsa